

SPECIFICATIONS

Features

- Work for most 3-wire/2-wire dimmer
- Compact size
- Low profile / Bottom Wire Exit
- Constant Current Output
- Active Power Factor
- Class II compliance
- 5 Year Warranty

Wiring Diagram

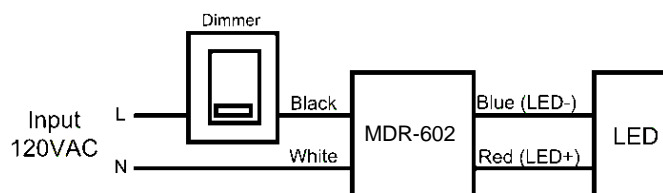

Mechanical and Thermal

Dimensions	L 3.878" x W2.047" x H1.171"
Weight	245 g
Lead Wire Length	6" (Standard)
Max. Case Operation Temp.	80°C

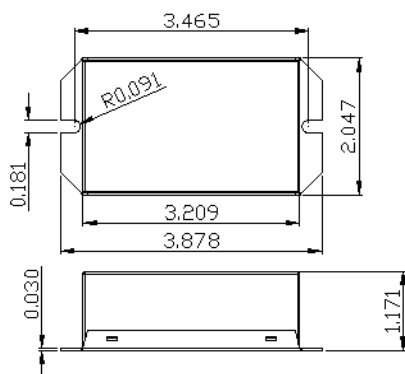

* Dimension in Inch

Protection

- Auto-reset electronic short circuit
- Overload protection
- Thermal protection
- Class II

Environmental Specifications

- MTBF >100,000 hrs
- RoHS Compliant
- Lead Free SMT process
- Power Factor Correction / Low Load
- FCC Part 15 class B compliant

Electrical

Maximum Load	10W
Minimum Load	7W
Input Voltage	120V/60Hz
Max Output Voltage/Current	45VDC/220mA
Power Factor	>0.90
Max. Harmonic Distortion	<20%
Efficiency	78 typ.
No Load Loss	<1 W
TRIAC dimmable (2 wire & 3 wire dimmer)	
(see dimming compatibility)	



Note –

1. UL file No.: E340871



Macron Associate Co. – Power Supply Team

NO.352, Peng-Yi Road, Taiping, Taichung, Taiwan 411

TEL: 886-4-22708357 FAX: 886-4-22767307 Email: macron@macrongroup.com

B1214

MDR 601 TRIAC Dimmable LED Driver

Updated Oct 8th, 2010

Case Dimension Table

Case 'D' / Compact Case with Side Leads

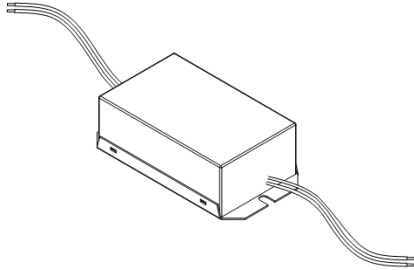

Dimensions

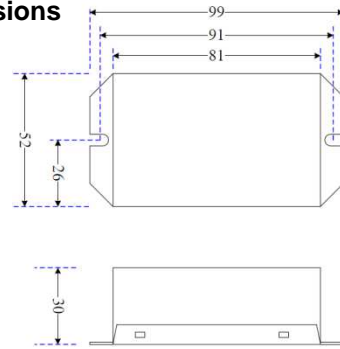

Case 'DJ' / Bottom Exit with Stud

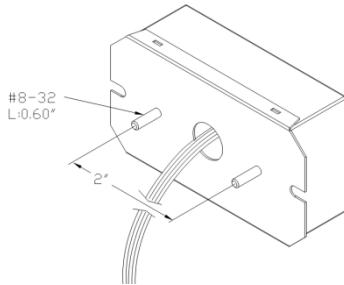

Dimensions

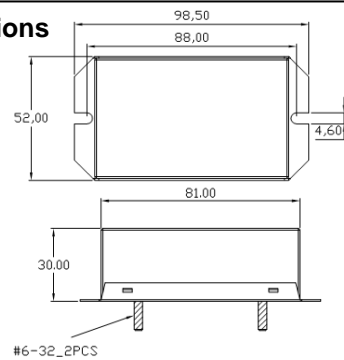

Case 'T' / Slim Case with Side Leads

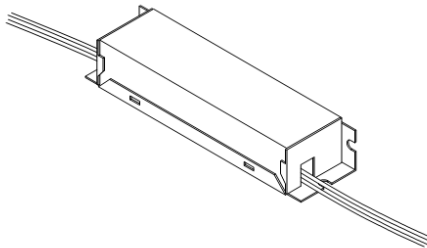

Dimensions

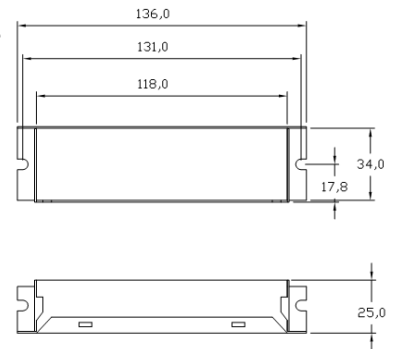

Case 'TT' / Tiny Case with Side Leads

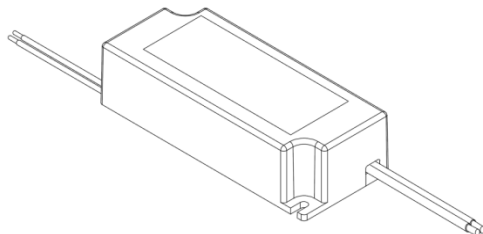

Dimensions

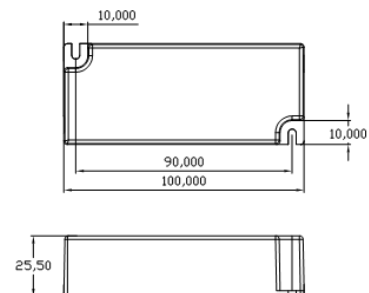

Macron Associate Co. – Power Supply Team

NO.352, Peng-Yi Road, Taiping, Taichung, Taiwan 411

TEL: 886-4-22708357 FAX: 886-4-22767307 Email: tonyw@macrongroup.com

A0811